



LOWFLOW

a division of Jordan Valve

Fractional Flow Control Valves & Regulators

- *Low flow control valves*
- *Heavy duty control valves*
- *High pressure regulators*
- *Self-operated pressure regulators*



Fractional Flow Control Valves

Mark 708 Series Fractional Flow Control Valves

A line of pneumatic and electric control valves specifically for fractional flow services. Now standard with the quick change trim for applications requiring frequent trim changes without disturbing the actuator setting (Cv's 0.05 and greater). Inlet pressures up to 5,000 psi (348 bar).

Seat Type	Globe/Needle – Class IV or VI
Sizes	1/4" – 3/4" (DN8 – DN20)
End Connections	Threaded, Socket Weld, Integral Tube, Welded Flanged
Body Materials	Carbon Steel, Stainless Steel, Hastelloy C, Monel, Alloy 20, others
Cv (Kv)	0.00001 to 4.0 (0,000009 to 3,4)
Ranges	3-15 or 6-30 psi; split ranges are available with optional positioner



Mark 708BS Series Bellows Stem Seal

The Mark 708 bellows stem seals eliminate fugitive emissions by surrounding the valve stem with a pressure tight barrier, isolating the stem from the process fluid and preventing leakage to the atmosphere. Inlet pressures up to 1,500 psi (103 bar). Top mount positioner standard.

Seat Type	Globe/Needle – Class IV or VI
Sizes	1/4" – 3/4" (DN8 – DN20)
End Connections	Threaded, Socket Weld, Integral Tube, Welded Flanged
Body Materials	Carbon Steel, Stainless Steel, Hastelloy C, Monel, Alloy 20, others
Cv (Kv)	0.00001 to 4.0 (0,000009 to 3,4)
Ranges	3-15 or 6-30 psi; split ranges are available; optional side-mounted positioner



Mark 708CR Series Cryogenic Bonnet

The Mark 708 for cryogenic service features an extended bonnet that provides protection for the packing and actuator by preventing ice build-up which can interfere with the movement of the valve stem and affect valve performance. Minimum temperature to -425°F (-254°C).

Seat Type	Globe/Needle – Class IV or VI
Sizes	1/4" – 3/4" (DN8 – DN20)
End Connections	Threaded, Socket Weld, Integral Tube, Welded Flanged
Body Materials	Carbon Steel, Stainless Steel, Hastelloy C, Monel, Alloy 20, others
Cv (Kv)	0.05 to 4.0 (0,04 to 3,4)
Ranges	3-15 or 6-30 psi; split ranges are available with optional positioner



Mark 708HT Series with Finned Bonnet

The cooling finned bonnet option is for the protection of the stem packing and actuator from elevated temperatures. Maximum pressure is 3460 psi @ 800°F (238 bar @ 427°C). Top mount positioner standard.

Seat Type	Globe/Needle – Class IV or VI
Sizes	1/4" – 3/4" (DN8 – DN20)
End Connections	Threaded, Socket Weld*, Integral Tube, Welded Flanged* (*1/2" & 3/4" only)
Trim Materials	Carbon Steel, Stainless Steel, Hastelloy C, Monel, Alloy 20, others
Cv (Kv)	0.05 to 4.0 (0,04 to 3,4)
Ranges	3-15 or 6-30 psi; split ranges are available; optional side-mounted positioner



Fractional Flow Control Valves

Mark 708HP Series High Pressure

The Mark 708HP manufactured in a variety of materials making it the perfect choice for demanding applications in the Oil & Gas industry including subsea, chemical and refinery pilot plants and R & D facilities. Maximum inlet pressure is 8000 psi. Side mount positioner standard.

Seat Type	Globe/Needle – Class IV
Sizes	1/2" (DN15)
End Connections	Threaded (FNPT), Autoclave, Socket Weld, Butt Weld
Body Materials	Carbon Steel, Stainless Steel, Hastelloy C, Monel, Alloy 20, others
Cv (Kv)	0.05 to 1.25 (0,04 to 1,08)
Ranges	3-15 or 6-30 psi; split ranges are available; optional top-mounted positioner



Mark 708LMO Series Motor Valve

The Mark 708LMO offers many advantages including extreme accuracy, high turndown ratios and repeatability. The features of this high resolution, low hysteresis digitally controlled motor makes the MK708LMO a premiere control valve. Lower cost option to the MK708MV.

Seat Type	Globe/Needle – Class IV or VI
Sizes	1/4" – 3/4" (DN8 – DN20)
End Connections	Threaded, Socket Weld, Integral Tube, Welded Flanged
Body Materials	Carbon Steel, Stainless Steel, Hastelloy C, Monel, Alloy 20, others
Cv (Kv)	0.00001 to 4.0 (0,000009 to 3,4)
Command Signals	Current or Voltage Command



Mark 708MV Series Motor Valve

The Mark 708MV is a premiere control valve for applications involving chemical injection, dosing, pilot plants and research labs. It offers several advantages including extreme accuracy, high turndown ratios, and repeatability

Seat Type	Globe/Needle – Class IV or VI
Sizes	1/4" – 3/4" (DN8 – DN20)
End Connections	Threaded, Socket Weld, Integral Tube, Welded Flanged
Body Materials	Carbon Steel, Stainless Steel, Hastelloy C, Monel, Alloy 20, others
Cv (Kv)	0.00001 to 4.0 (0,000009 to 3,4)
Command Signals	Current or Voltage Command, On/Off



Mark 709 Series Three Way Fractional Flow Control Valves

The Mark 709 is a lightweight control valve for use as a mixing valve in low flow process applications. Featuring a three-way body design, it is constructed with two inlets to blend two separate flow streams into a common outlet, creating a third fluid.

Seat Type	Globe/Needle – Class IV or VI
Sizes	1/2" & 3/4" (DN15 & DN20)
End Connections	Threaded, Socket Weld, Flanged
Trim Materials	Carbon Steel, Stainless Steel, Hastelloy C, Monel, Alloy 20, others
Cv (Kv)	1.25 to 4.0 (1,06 to 3,4)
Ranges	3-15 or 6-30 psi; split ranges are available with optional positioner



Fractional Flow Control Valves

Mark 8000 Series

The Mark 8000 is a group of heavy-duty control valves specifically designed for process applications requiring full flow or fractional flow control. The valve subassembly is manufactured completely from barstock. Inlet pressures up to 6,000 psi (414 bar).

Seat Type	Globe or Angle – Class III, IV or VI
Sizes	1/2" – 2" (DN15 – DN50)
End Connections	Threaded, Socket Weld, Flanged, Butt Weld
Body Materials	Carbon Steel, Stainless Steel, Brass, Hastelloy C, PVC, Kynar, others
Cv (Kv)	0.05 to 17 (0,04 to 14,5)
Ranges	3-15 or 6-30 psi; split ranges are available with optional positioner



Mark 8000 Series Bellows Stem Seal

Bellows stem seals eliminate fugitive emissions by surrounding the valve stem with a pressure-tight barrier, isolating the stem from the process fluid and preventing leakage to the atmosphere. Inlet pressures up to 1,500 psi (103 bar).

Seat Type	Globe – Class III, IV or VI
Sizes	1/2" & 3/4" (DN15 & DN20)
End Connections	Threaded, Socket Weld, Flanged, Butt Weld
Body Materials	Carbon Steel, Stainless Steel, Brass, Hastelloy C, others
Cv (Kv)	0.05 to 3.0 (0,4 to 2,6)
Ranges	3-15 or 6-30 psi; positioner recommended, split ranges available w/ pos.



Mark 8000 Series Cryogenic Option

The cryogenic option offers a bonnet extension that provides protection for the packing and actuator by preventing the formation and build-up of ice, which can interfere with movement of the valve stem and affect valve performance. Minimum temperature to -425°F (-254°C).

Seat Type	Globe – Class III, IV or VI
Sizes	1/2" – 2" (DN15 – DN50)
End Connections	Threaded, Socket Weld, Flanged, Butt Weld
Body Materials	Carbon Steel, Stainless Steel, Brass, Hastelloy C, others
Cv (Kv)	0.05 to 17 (0,04 to 14,5)
Ranges	3-15 or 6-30 psi; split ranges are available with optional positioner



Mark 8000 Series Three Way Body

The three-way Mark 8000 can be specified for use on mixing or diverting services. Uses include mixing two separate flow sources into one common line or diverging a single flow path into two separate streams. Inlet pressures up to 6,000 psi (414 bar).

Seat Type	Globe – Class III, IV or VI
Sizes	1/2" – 1" (DN15 – DN25)
End Connections	Threaded, Flanged, Socket Weld
Body Materials	Carbon Steel, Stainless Steel, Brass, Hastelloy C, others
Cv (Kv)	0.2 to 6.0 (0,17 to 5,1)
Ranges	3-15 or 6-30 psi; split ranges are available with optional positioner



Fractional Flow Control Valves

JR Series

The JR Series have the ability to handle very high pressures and very low flows. Typically used in research and sampling systems for corrosive and specialty gases. Typical applications include gas chromatography and flame ionization detectors. Inlet pressures up to 4000 psi.

Seat Type	PTFE, PEEK
Sizes	1/4", 3/8", 1/2" (DN8, DN10, DN15)
End Connections	Threaded (NPT), Socket Weld, Flanged
Body Materials	Stainless Steel, Hastelloy C, Monel, Alloy 20, others
Diaphragm Materials	Jorlon
Setpoints	up to 750 psi (up to 52 bar)



JRC Series

The JRC Series is ideal for corrosive and non-corrosive gas services. It is designed to handle fluctuations in supply pressure while maintaining precise, accurate outlet pressure control. Inlet pressures up to 4000 psi.

Seat Type	PTFE, PEEK
Sizes	1/4", 3/8", 1/2" (DN8, DN10, DN15)
End Connections	Threaded (NPT), Socket Weld, CGA
Body Materials	Stainless Steel, Hastelloy C, Monel, Alloy 20, others
Diaphragm Materials	Jorlon
Setpoints	up to 750 psi (up to 52 bar)

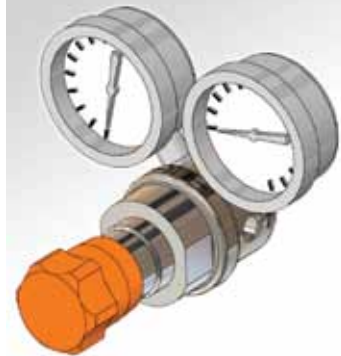

Mark 5800HP Series High Back Pressure Regulator

The Mark 5800HP Series is a high pressure, back pressure regulator designed to maintain upstream pressure of gases and liquids. As a lightweight product, it is well suited for applications where space and weight are at a premium. Inlet pressures up to 2500 psi (172 bar).

Seat Type	Teflon (standard), PEEK, Delrin
Sizes	1/2" – 1" (DN15 – DN25)
End Connections	Threaded, Socket Weld, Flanged
Body Materials	316L Stainless Steel, others
Cv (Kv)	0.5 to 1.0 (0,4 to 0,86)
Setpoints	400 - 2500 psi (27,6 - 172 bar)



Mark 6800HP Series High Pressure Regulating Valve

A line of self-operated pressure regulating valves for use on high pressure industrial gas and liquid services to 3,800 psi (262 bar). The 6800HP features a balanced piston design for excellent stability even in high pressure drop situations.

Seat Type	Stellite, Vespel, Teflon
Sizes	1/2" – 1" (DN15 – DN25)
End Connections	Threaded, Socket Weld, Flanged
Body Materials	316L Stainless Steel, others
Cv (Kv)	0.5 to 2.5 (0,4 to 2,1)
Setpoints	250 - 3000 psi (17,2 - 207 bar)



To learn more about LowFlow Valve products and
to find the name of a local representative visit:
www.lowflowvalve.com



A Division of Jordan Valve
3170 Wasson Road
Cincinnati, OH 45209 USA

toll free. 800.543.7311
local. 513.533.5600
fax. 513.871.0105

email. lowflow@richardsind.com
website. www.lowflowvalve.com